

VERTICAL CLAMPS

V350 SERIES

MODEL V350/1C



Arm:
The spindle is in a fixed position.

Base:
Straight.

Nominal Holding Force:
350 daN

Weight:
0.75 Kg

Supplied complete with:
MB1080 Setscrew & nuts.

See "Accessories" for other items.

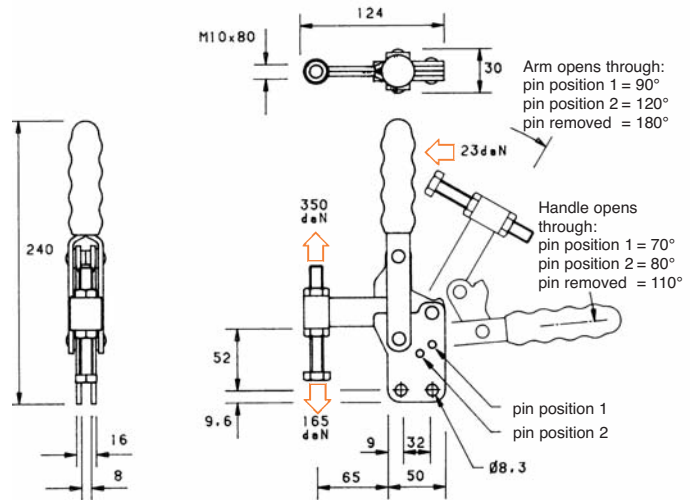

V350 SERIES

MODEL V350/2A



for front mounting use
bracket Model FM3

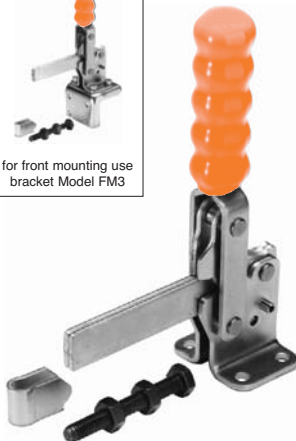

Arm:
Solid with spindle retainer supplied loose for welding in the desired position.

Base:
Flanged.

Nominal Holding Force:
350 daN

Weight:
0.80 Kg

Supplied complete with:
MB1080 Setscrew & nuts.
R/10 Spindle retainer.

See "Accessories" for other items.

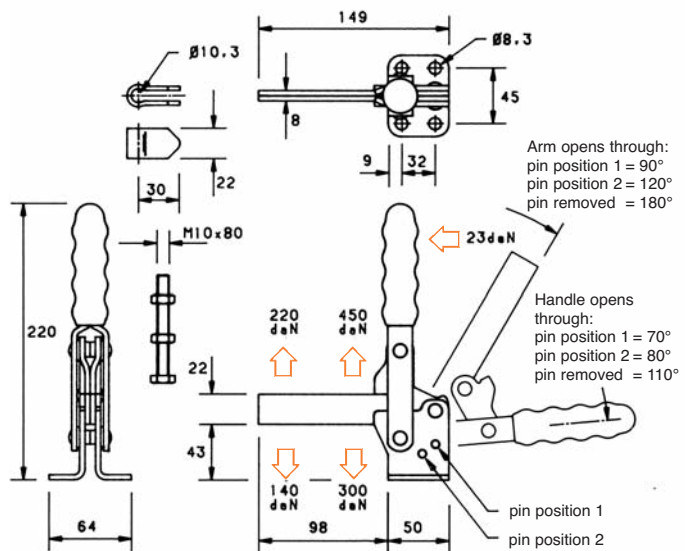

V350 SERIES

MODEL V350/2B



for front mounting use
bracket Model FM3

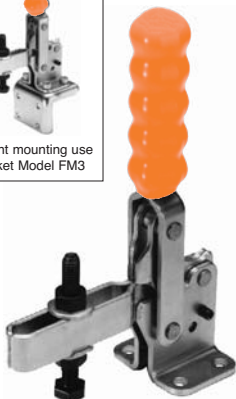

Arm:
The spindle position is adjustable along the arm.

Base:
Flanged.

Nominal Holding Force:
350 daN

Weight:
0.80 Kg

Supplied complete with:
MB1080 Setscrew & nuts.
FW10/20 Flanged washers.

See "Accessories" for other items.

